

Breathing Innovation into Ventilation!



AZURE





INDEX

ABOUT US.....	Page 4-7
COMPACT AIR HANDLING UNITS.....	Page 8-15
ANEMO Test Lab.....	Page 16-17
CERTIFICATION.....	Page 18-19
SENSO ⁺ CONTROL.....	Page 20-21
AZURE.....	Page 24-39

AERA is wherever you breathe fresh!

- Offices
- Hotels
- Shopping Malls
- Industrial Buildings
- Laboratories
- Hospitals
- Nursing Homes
- Conference Halls
- Concert Halls
- Banks
- Restaurants
- Cafes
- Exhibition Halls
- Museums
- Markets
- Malls
- Schools and Universities
- Stadiums and Sports Halls
- Stations and Airports



Inspiring Confidence, Powering Progress Globally

AERA products have achieved a global presence, captivating markets across Europe, the Middle East, and beyond.





Welcome to AERA

Breathing Innovation into Ventilation!

Born in the innovative surroundings of the Bilimpark – Science and Technology Development Zone, AERA started with a dedicated Product Development Team with a simple mission: to enhance air quality everywhere.

2016 In 2016, we moved to our foundational facility in Pancar Industrial Zone. Covering over 3,000 m², this space is equipped with modern machinery, ensuring our products meet the highest standards and reach you efficiently.

That same year, we established our domestic sales office in Istanbul, marking our commitment to serve both local and international customers.

2017 was a pivotal year for us as we introduced our Modular Air Handling Units and Heat Recovery Ventilators to the market. By mid-2017, we began our journey towards achieving international certifications, ensuring our solutions stand up to global standards.

By the close of 2017, AERA broadened its portfolio with the introduction of the Compact Air Handling Units family. This range catered to diverse needs, including horizontal units for ceiling mounting and versatile standing units, both with plate and rotary heat recovery options.



Our commitment to innovation didn't stop there. In collaboration with a leading AHU Control Components manufacturer, we co-developed distinctive air handling unit controls. These state-of-the-art controls, conceived and crafted through international expertise, made their debut in the market the very same year.

2018 Recognizing the burgeoning industry demand and our ever-growing aspirations, 2018 was a significant milestone: We acquired a spacious factory land spanning 10,000 m², setting the stage for further advancements and the promise of bringing even more refined ventilation solutions to our valued clientele.

The journey of AERA has always been marked by innovation and collaboration. A testament to this is our pioneering partnership with TUBITAK (Turkey's Scientific and Technological Research Council). This collaboration bore fruit in the form of our first government-subsidized development project. Our unique product designs further paved the way for us to receive State Funds, establishing our R&D Centre of Excellence.

Our commitment to excellence was recognized globally in 2018 when EUROVENT certified our modular AHU range. This acknowledgment, particularly for outstanding casing performance (T2/TB2, EN 1886), set us apart. That year, our drive for innovation continued unabated, with the inception of development projects centered around panel casing design and ceiling-mounted air handling units equipped with rotary wheels.





AERA's name has grown to resonate powerfully, both within Turkish borders and beyond.

Our distinction lies not just in our products but also in our unparalleled service offerings. This has enabled us to stand tall, often being the preferred choice over renowned competitors for state-of-the-art design projects.

2021 In a pivotal move at the end of 2021, we saw the completion of our new production plant. This state-of-the-art facility now houses the majority of our production activities and operational offices, reflecting our relentless pursuit of growth and excellence.

2023 In the quest for healthier indoor spaces, we've made a major stride!

We are proud to announce a significant achievement in our commitment to quality and health: our Air Handling Units have earned the **Hygienic Certificate from TÜV SÜD**.



With AERA, it's always about bringing cleaner, fresher air to spaces everywhere. We're here to serve, innovate, and grow alongside our community. AERA started with a dedicated Product Development Team with a simple mission: to enhance air quality everywhere.

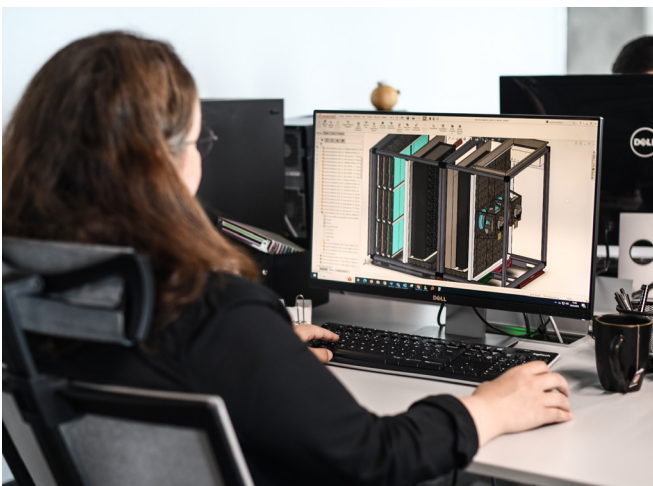

COMPACT AIR HANDLING UNITS

AERA Compact Air Handling Units efficiently supply conditioned outdoor air to meet specific requirements while simultaneously expelling indoor air. They achieve exceptional heat and energy efficiency through advanced counterflow or rotary heat recovery heat exchangers.

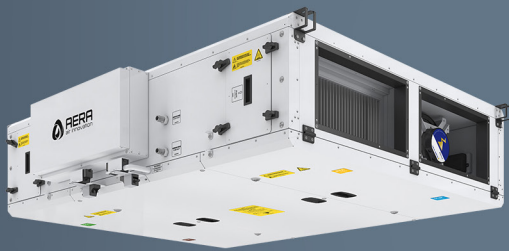

AZURE

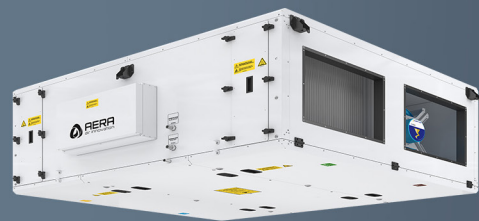

AZURE Wheel *



EVO-C



EVO-R



EVO-C^{TOP}



EVO-R^{TOP} *

* Models so marked are not Eurovent certified.



Why go Compact?

Why not?

Compact Air Handling Units, provide unique solutions in ventilation applications with their high energy efficiency, low noise levels, and ease of installation and operation.

INDEPENDANT, LOCAL VENTILATION SOLUTION

- Localized solutions with airflow rates of up to 15,000 m³/h can be created with independant duct and distribution systems, ensuring ease of operation.
- Efficient solutions tailored to specific needs can be provided for variable demands depending on building facade and usage purpose.



Efficient Space Utilization and Cost Optimization.

ENHANCED LIVING / USAGE SPACE IN BUILDINGS

- Thanks to their compact design, they do not require large mechanical spaces/volumes.
- Ceiling-mounted compact air handling units can increase living spaces by utilizing suitable areas such as wet rooms and corridors.
- Floor-mounted compact air handling units can provide solutions in small/narrow mechanical spaces.
- They will eliminate the need for several vertical shafts and large duct dimensions. Two main ducts for outdoor and exhaust air and local duct and air distribution systems will be sufficient.



Installation: Simplified!

- Designed using high-efficiency, low-noise EC plug fans for enhanced aerodynamic efficiency. Equipped with fresh air and return air filters in compliance with ECO-DESIGN requirements.
- Deliver tailored solutions with heating, cooling, and humidification components, mounted on the unit casing and/or duct system, while providing operational ease through integrated controls.
- Thanks to its Plug-and-Play design, it is user-friendly, offering easy installation, quick commissioning, and BMS integration.
- Its compact structure, which takes up less space and offers alternative duct connection solutions, provides idealized solutions for commercial spaces, residences, office buildings, hotels, schools, and more.



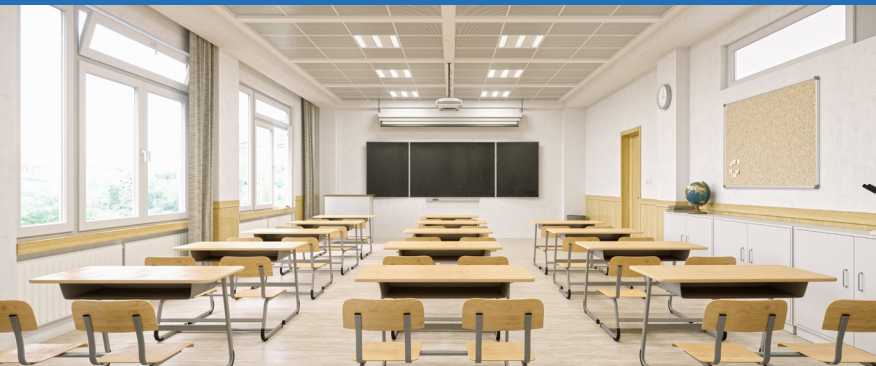

Our Compact Air Conditioning Units elegantly blend with your space, thanks to their minimalist footprint and quiet operation. They create operational efficiency with high energy efficiency and provide you with **top-tier comfort in indoor air quality!**

Thanks to their space saving design, compact air handling units provide **flawless solutions** for commercial spaces, residences, office buildings, hotels, schools, banks, and other structures.



Comparison of **MODERN and TRADITIONAL** air handling units

 Modern AHUs are designed to be more energy efficient, quieter, and controllable than traditional AHUs. They are also more flexible and easier to maintain.

 Traditional AHUs are less efficient, louder, and less controllable than modern AHUs. They are also less flexible and more difficult to maintain.

 If you are concerned about energy efficiency, noise levels, or controllability, then a modern AHU is a good option.





TRADITIONAL centralized AHU System

- ✗ More operating costs!
- ✗ More time and additional costs for installation, commissioning, and air adjustment!
- ✗ Larger mechanical space demand
- ✗ Increased visual congestion

LESS LIVING SPACE, MORE MECHANICAL SPACE!



- ✗ More labor and assembly costs



Additional requirements for precise air adjustment:

- ✗ CAV Box
- ✗ VAV Box
- ✗ Regulation Dampers



- ✗ The need for large air ducts for supply and exhaust, mechanical shaft demand, results in large non-commercialized spaces

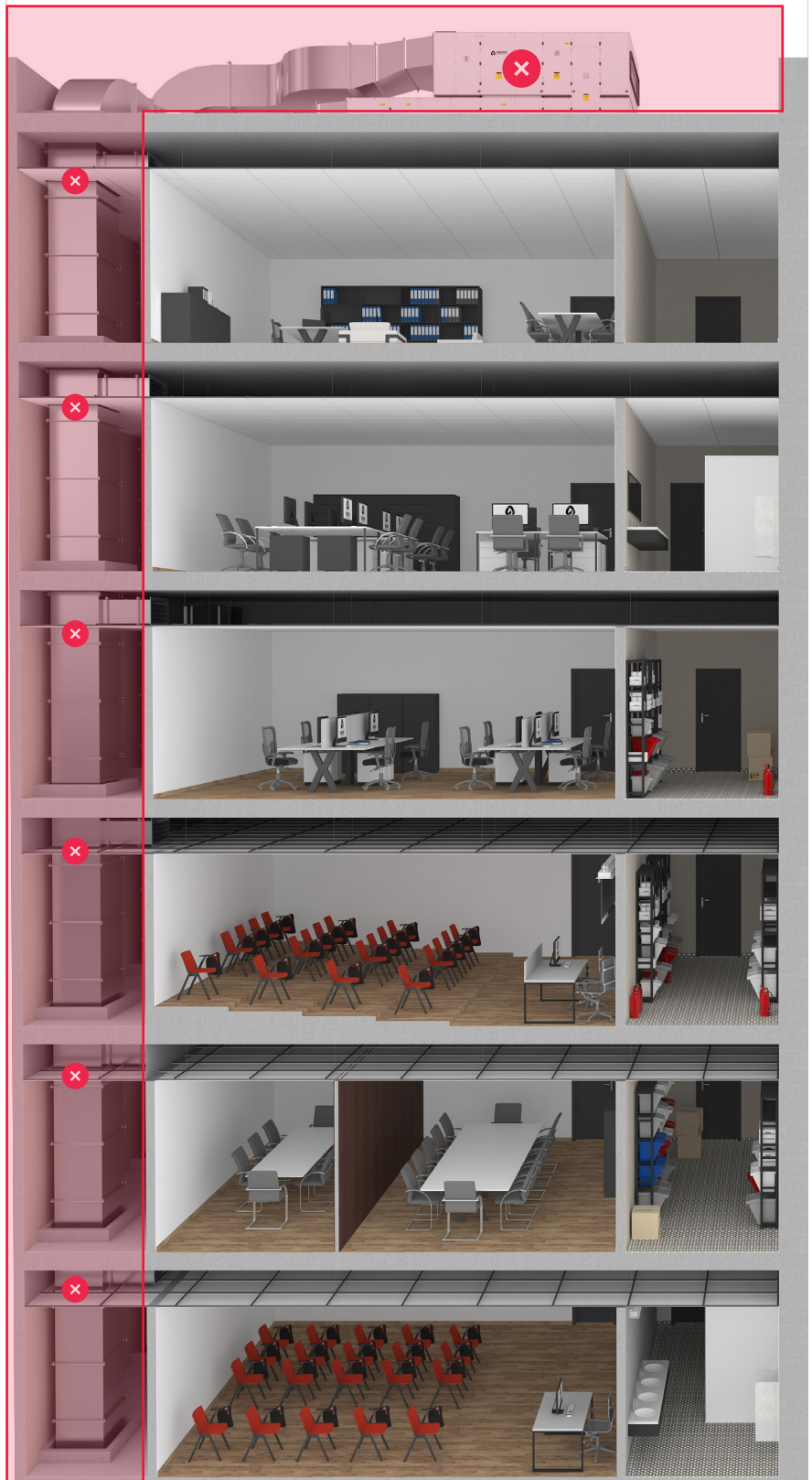

- ✓ Achieve lower energy consumption with easy plug-and-play installation.
- ✓ These units can be discreetly integrated into living spaces.
- ✓ Additional social spaces. Compact Air Handling Units can utilize the usage of terraces for green coverings such as gravel, grass, and similar natural materials, creating enjoyable living areas.

MORE LIVING SPACE, LESS MECHANICAL VOLUME! 

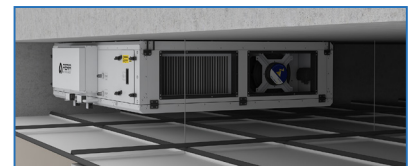

- ✓ By implementing them as suspended ceiling units, there is a substantial increase in commercial living space.



- ✓ They also offer the flexibility of placement in compact and multi-purpose volumes.

COMPACT AIR HANDLING UNITS

Compact Air Handling units are designed with high aerodynamic efficiency, utilizing EC Motors with Plug Fans to achieve **low noise levels and low energy** consumption.

HIGH EFFICIENCY / OPERATIONAL ECONOMY

- They offer up to **93%** temperature efficiency with counterflow or rotary heat recovery heat exchangers.
- Additionally, they provide up to **75%** humidity transfer ratio with sorption-type rotary heat recovery.
- Thanks to their high efficiency, they reduce the need for cooling and heating, enabling solutions with smaller capacities. This leads to reduced requirements of both equipment and labor for heating & cooling systems, pumps, pipes, insulation and system accessories.
- The use of IE4 efficiency class EC fans with aerodynamic design results in energy savings compared to other fan types.

LOW NOISE LEVELS

- Aerodynamic EC fans are used to reduce sound power levels.
- The double-walled casing structure and rock wool insulation contribute to environmental noise reduction.

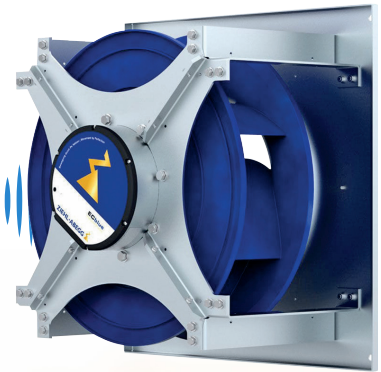



Remote connectivity with AERA Cloud

SOFTWARE / BIM / DOCUMENTATION

- Web-based and user-friendly EUROVENT certified selection program
- BIM library

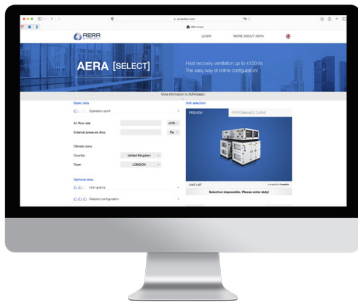

EASY-TO-USE CONTROL SYSTEM

- User-friendly, flexible advanced control with SENSO+ control system
- Language options: TR, ENG, FR
- Compatibility with BMS (Building Management System) via Modbus TCP/IP and Bacnet IP protocols
- Remote connectivity with AERA Cloud
- Communication with fire alarm panel
- Options for constant air volume (CAV), variable air volume (VAV), and demand-controlled ventilation (DCV)
- PID control

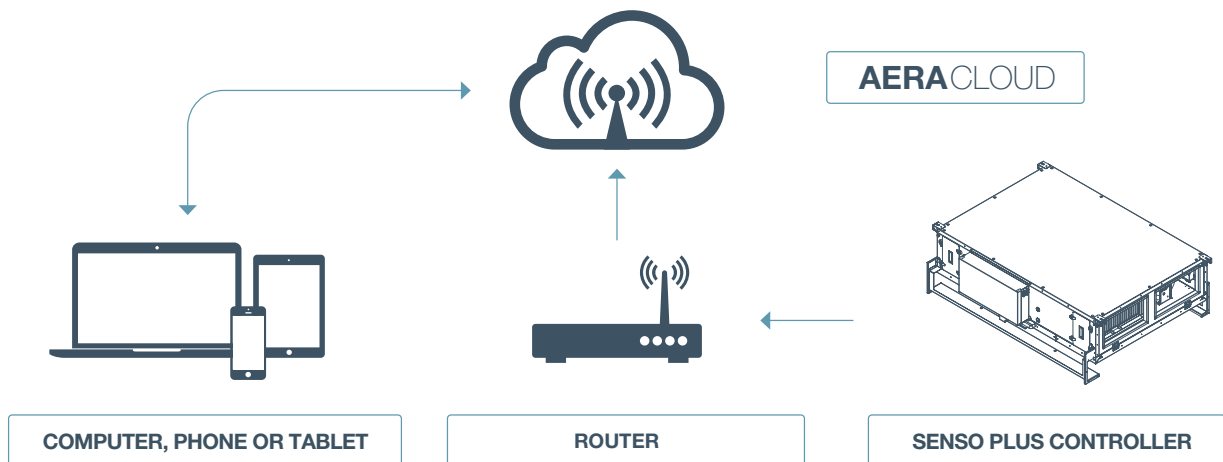

Reference Standards

- EN 308
- EN 1886
- EN 13053
- EN 13779
- EU No 1253/2014 ECO-DESIGN
- EN 305
- ISO 5167-4:2003



ANEMO AERA, committed to creating energy-efficient ventilation products, has developed its products in alignment with market expectations and demands. They have implemented robust quality management and quality control systems to ensure sustainability. Beginning with customer relationship management, we have made our management philosophy traceable, measurable and transparent, including design, procurement, production and after-sales services. Internal trainings and preventive activities are performed by evaluating the harvested data and are delivered as a part of our continuous improvement policy. At AERA, every product we manufacture undergoes rigorous quality control processes, starting from the component level, and is carefully monitored at every stage of production.

The air handling units undergo testing and certification by independent organizations. Additionally, tests are conducted at the ANEMO laboratory in accordance with European norms and directives, guaranteeing consistent product quality.

The logo for ANEMO testlab features a stylized circular icon on the left, composed of several overlapping, curved segments that create a sense of motion or a globe. To the right of this icon, the word "ANEMO" is written in a large, bold, black, sans-serif font. Below "ANEMO", the word "testlab" is written in a smaller, lowercase, black, sans-serif font.

- EN 308
- EN 1886
- EN 13053
- EN 13779
- EU No 1253/2014 ECO-DESIGN
- EN 305
- ISO 5167-4:2003

Intensive quality control

Testing what is produced not only allows us to understand the quality of the existing product but also ensures the continuous improvement of future products.

At AERA, our commitment to quality is unwavering and central to our operations. We believe in delivering nothing less than the best to our valued customers. To achieve this, we implement a rigorous 100% quality control inspection on all our finished goods, ensuring that every product meets the highest standards. Recognizing the criticality of each stage in the assembly process, we've instituted a comprehensive checklist for pre-assembly processes. Every assembled part is meticulously checked before it progresses to the subsequent station, ensuring accuracy and excellence at every juncture. By continually monitoring and recording quality data, we gain invaluable insights into our strengths and areas that require enhancement. This approach not only aligns with the best practices of the HVAC industry but also sets a benchmark, reinforcing our constant endeavor to ensure that every product delivered to our customers is of the highest quality possible.

ECO DESIGN

All manufacturers are legally obliged to follow ECO-DESIGN directives, which are a set of the European Union's regulations that state use of energy for energy-consuming products. LOT6 of the directive reviews the ventilation devices and air handling units and is effective in the European Parliament with the EU directive number 1253/2014 and 1254/2014. The ECO-DESIGN directives, prepared by the European Council for the purpose of replacing low energy-efficient products in the market with those of high efficiency, have been accepted as a prerequisite for CE marking with the dates specified and the entry of nonconforming devices into EU countries is prohibited. Within the scope of the ECO-DESIGN directive, which has been in force since January 1st 2016, a number of sub-limit values have been defined for air handling units, such as fan, heat recovery exchanger and filter efficiency. Thermal bypass and visual monitoring of filter arrestance has become compulsory with the directive also.

All air handling units produced at AERA are designed and manufactured according to ECODESIGN criteria



“Sustainability is no longer about doing less harm. It’s about doing more good .”

Jochen Zeitz



EUROVENT CERTIFICATION

Companies operating in the ventilation and air conditioning industry established the EUROVENT association and subsequently the association's certification body, Eurovent Certita Certification, to ensure that the performance of the units they produce can be evaluated based on common criteria, independent of local standards of countries. Today, with over 1000 members and offices in many parts of the world, EUROVENT is responsible for the certification and listing of many HVAC components such as Air Handling Units, Fan Coil Units, Roof Top Units, Chiller Units, and Air Conditioning devices through its 48 certification programs.

Air handling units are composed of components such as fans, water coils, heat recovery exchangers, filters, and humidifiers, brought together in different configurations. These components are placed inside a casing that possesses heat and sound insulation. The EUROVENT Certification program classifies the casing of the air handling unit according to the EN 1886 standard and approves thermal, acoustic, and electrical values in the data sheet created by the configuration and selection software by testing them according to EN 13053 standard.

According to EN 1886, the acoustic absorption, thermal bridging value, heat transfer coefficient, leakage values under negative and positive pressure, and deflection of the casing named MODEL BOX are measured. In EN 13053 tests, units' performance values are measured and compared with the selection data sheet. Additionally, the energy label value of the unit provided in the selection software is also approved.

AERA Compact air handling units can be selected on www.aerselect.com and AERA Modular Air Handling Units can be selected through AERA Modular AHU selection software; both have been verified as a result of tests conducted by EUROVENT. Moreover, all the Model Boxes in AERA's product portfolio have been tested according to EN 1886 and their performances have been documented.



Compliance with hygienic requirements (used materials / accessibility/cleanability) acc. to:

- VDI 6022-1
- VDI 3883-1
- DIN EN 13053

www.tuvstd.com/kaehte-klima

VDI 6022 HYGIENE CERTIFICATION

Air handling units are designed and produced to introduce conditioned clean air into the indoor environment. Due to

temperature differences between the indoor and outdoor environments and the characteristics of the transferred air, bacteria and mold formation are observed in points where maintenance is not possible if the correct components are not used or due to errors in unit design. Especially since the 1980s, for air conditioning systems, to prevent the formation of bacteria causing Legionnaires' disease, all components except those made of metal inside the device need to be observed with the ISO 846 test for the absence of bacteria or mold formation. The German Engineers Association (VDI) guarantees safety of air handling units with VDI 6022 standard, which specifies hygiene conditions in air handling units, and does this through a certification program. During the certification process, while the components found inside the air handling units are approved against bacteria and mold formation with ISO 846 test, the body of the air handling unit is also tested and certified based on measures taken for cleanability and removal of condensation.

AERA Compact air handling units have completed this certification process and have earned the VDI 6022 Hygiene certificate.

AERA Compact air handling units have completed this certification process and have earned the VDI 6022 Hygiene certificate.

SENSO+

The advanced control system SENSO PLUS in all Units, provides the most efficient control of all components which can be installed internally and as external accessories, ensuring the desired airflow conditions.

The SENSO PLUS control also provides system control besides equipment control, which means that the devices can be operated with the Yearly Timer Function according to the working periods: Daily, Weekly, Monthly or Yearly.

In the Timer Function, values such as weekly working days, vacation times, daylight savings time can be defined and reported retrospectively.

Besides, the Support Function which is used to prevent the undesired conditions from occurring indoors even when the device is not working. The indoor temperature from falling below or exceeding a certain value even during non-working hours is ensured.

INDOOR AIR QUALITY CONTROL

The air quality sensor or the CO₂ sensor, which is placed in the critical volume or return channel in the interior, continuously measures the air quality. This value generates a signal that will change the EC fan speed by comparing it to the set point on the controller. If the indoor air quality is lower than the desired value, the fan speed and thus the fresh air amount is increased; if the indoor air quality is higher than the desired indoor air quality, the fan speed and fresh air speed are decreased; Energy saving is achieved in considerable amounts in heating or cooling loads caused by fresh air.

CONSTANT FLOW CONTROL

To meet the desired constant airflow requirement in the EVO Compact Air Handling Units, the SENSO PLUS control measures the air pressure drop in the suction ports of the fans and compares the air flow with the set value to produce a working signal that will change the EC fan speed.

Contamination of the filters can be controlled by static flow control within the fan operating curve, to the static pressure requirements of the unit which result in higher or lower than the project values.

CONSTANT PRESSURE CONTROL

In EVO Compact Air Handling Units, constant pressure control is used to meet the variable airflow requirement of the air duct system. The SENSO PLUS control generates a working signal that will change the EC fan speed by continuously measuring the static pressure created in the supply air duct and comparing it with the value defined in the system. When a VAV damper opens or closes, higher or lower external static pressure needs can be met with constant pressure control within the fans operating curve. This way extreme noise in the ducts, unbalanced airflow distribution in different volumes is prevented.

FILTERS

The pressure drops of the filters used to clean the air, can be controlled by SENSO PLUS control. Users are notified about the filter cleaning and replacement intervals. Pressure drop control can be made according to a constant pressure drop (Static) or variable air flow (Dynamic). Especially with units designed with variable speed fans, Dynamic Filter Control enables filter service at the right time.



HEATING COIL

Heating coils are used for increasing the supply air temperature and for bringing the supply air to the desired temperature after dehumidifying process. Hot water coils can be driven by proportional control via 2 or 3 way valves. With the SENSO PLUS control, frost protection mechanism is available as standard to prevent the temperature of the supply water from reaching freezing conditions in extreme cold climates. If the return water temperature falls below a certain value set on the control, the heating valve is switched to the 100% open position and a run signal is sent to the heating water circulation pump. If the temperature still does not rise to the desired value, the device is stopped and the user is given a freeze alarm.

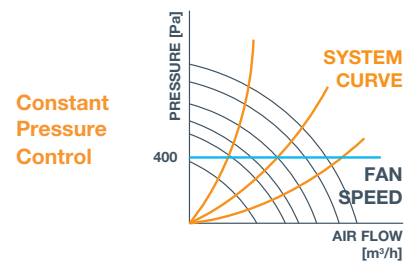
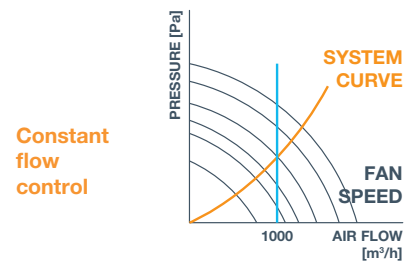

COOLING COIL

Externally mounted duct-type water cooling coils are used for such purposes as lowering the blowing temperature and dehumidifying the air in the units. It can be driven either proportionally or by on / off method.

DX COIL

Externally mounted duct type DX batteries are used for purposes such as lowering the supply air temperature, dehumidifying process and bringing the blown air to the desired temperature after dehumidification. It can be step controlled with on / off method, maximum 8 step setting is available.

HUMIDITY CONTROL

Humidity control equipments are used to raise or lower the humidity of the supply air. With the SENSO PLUS control, the humidifier / de-humidifiers can be controlled to bring the supply air to the desired humidity value.



Everything is under your control with SENSO+

With the Cloud feature, the device's operating mode and settings can be changed and alarms can be monitored from any device connected to the internet.

USER INTERFACE

EVO ECO button control panel or EVO TOUCH touch screen control panel is offered with SENSO+. There is also a web server integrated into the card for monitoring and controlling the device via a computer. Control settings can be made via the server, and both current and historical operating values of the device can be monitored.

SENSO PLUS control connects the web server over the internet and allows you to view and change the settings of your unit on any computer / tablet or mobile phone anywhere in the world. No need for complicated network settings, only a connected network cable is enough. With this feature, it is possible to monitor and control all units from different projects on a single screen, so that all of the operating values, active alarms, settings can be observed and remotely changed. Cloud control is an option provided with SENSO PLUS, which is especially convenient when it is important to serve multiple devices within seconds, in different projects all around the world.

If desired, devices in different projects can be collected on a single screen and their operating values, active alarms, etc. can be displayed at the same time. It is possible to intervene by observing the values. This system, which provides great convenience especially in projects where multiple devices are used or when servicing many devices in different locations, is optionally provided with SENSO+.

COMPLIANCE WITH INTERNATIONAL COMMUNICATION PROTOCOLS

SENSO PLUS control supports all of the universal communication protocols and interacts with other air handling units as well as with other building automation systems. ModBUS, BACnet and EXOline protocols are open as standard and there is also possibility to connect with LONWORKS protocol as an option.



VENTILATION MODE: NORMAL RUN

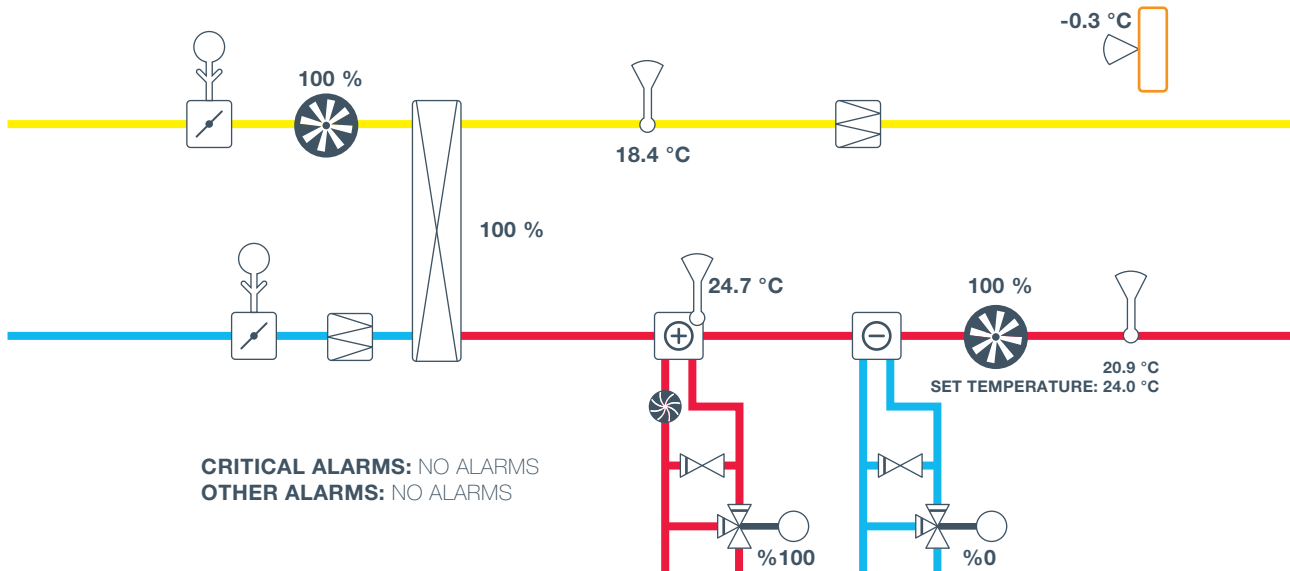

AZURE

Ceiling-type air handling units with high energy efficiency, advanced control capabilities, quiet operation, and plug-and-play functionality are designed for spaces where stale indoor air needs to be removed while providing fresh air.

These units are compact in structure, designed for both bottom and side dual-service orientation. Their ceiling installation eliminates the need for additional mechanical space, significantly increasing available commercial space in applications.

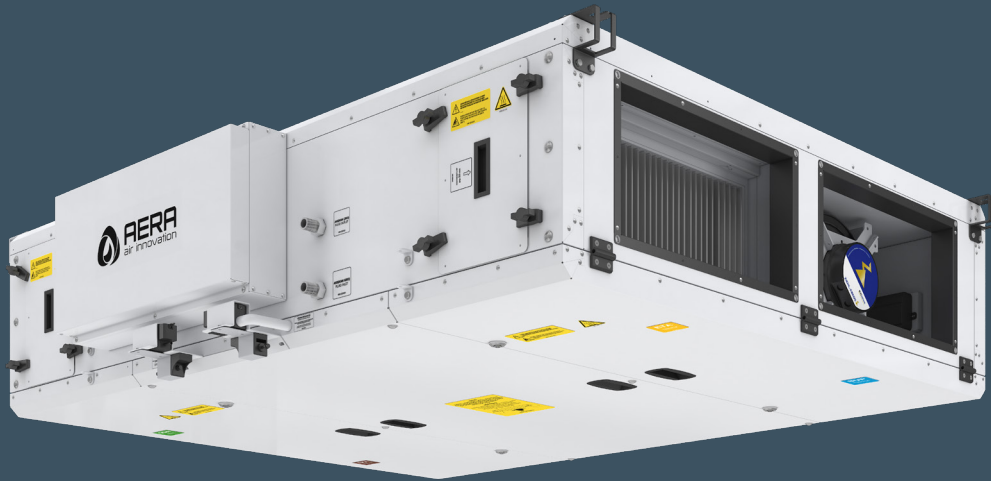

- Optimized in 6 different models with a flow rate range of 150-3500 m³/h.
- A compact design, well-suited for indoor building installation with insulated double wall casing.
- Ideal solution for low-ceiling space applications.
- Low internal pressure drop.
- Both bottom and side servicing options come as standard.
- Standard bypass damper.
- Integrated electric pre-heater and electric/water final heater options inside the unit casing.
- External duct-type water cooler or DX cooler/heater module options.
- Web-based and user-friendly selection software at www.aereselect.com.
- BIM files for Revit and MagiCad applications.

CASING

- Inner sheets made of AZ 150 Aluzinc.
- Outer sheets made of galvanized steel with powder coating
- Insulated with 50 mm thick rock wool of 70 kg/m³ density.
- Thermal transmittance T2, Thermal bridging class TB2.
- High air tightness

HEAT EXCHANGER

- Counterflow heat recovery exchanger achieving up to 93% efficiency at nominal flow rates.
- Standard By-pass damper
- Free cooling capability.
- Exceptional air tightness between fresh air and exhaust air flows.

FAN

- Superior aerodynamic efficiency.
- Low noise levels and energy consumption.
- Plug fans with IE4 efficiency class EC motors.
- Fan selection in compliance with ECO-DESIGN criteria.
- AC-powered, DC motor technology for speed control.

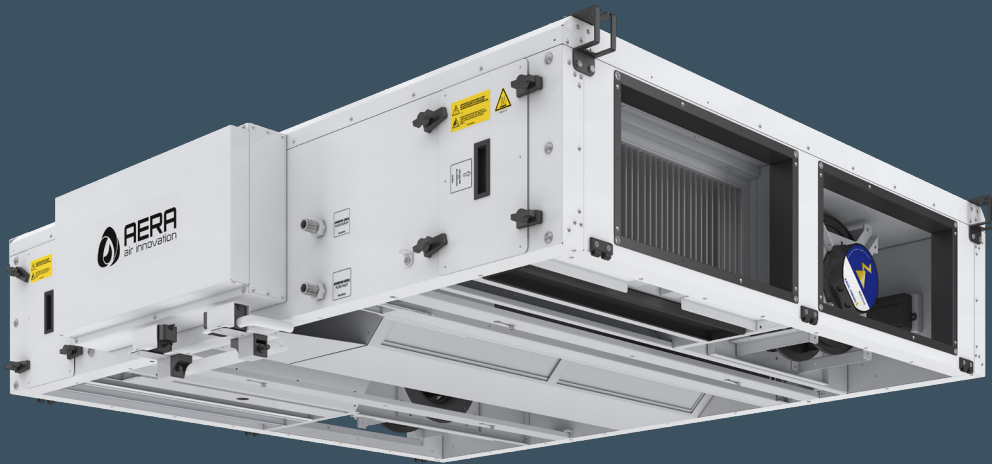

FILTER

- ECO-DESIGN compliant ePM1 55% (F7) class filter on the fresh air side, and ePM10 50% (M5) filters on the exhaust side, as standard.
- Dynamic filter cloaking measurement.
- Optional use of ePM1 80% (F9) filter for enhanced filtration performance.

PLUG-PLAY

Design-in every aspect

- Integrated controls.
- Simplified installation.
- Swift commissioning.
- Convenience in attic solutions with its low height,

CONTROLS & CONNECTIVITY

- Constant air volume (CAV), variable air volume (VAV), and demand-controlled ventilation (DCV) options.
- Optional indoor air quality control
- Temperature control.
- Humidity control.
- Standard Bacnet IP or Modbus TCP/IP BMS connections, with future connectivity option LONWORKS
www.AERACLOUD.com Cloud Access
- Dry contact communication with fire alarm panel.

AZURE 500

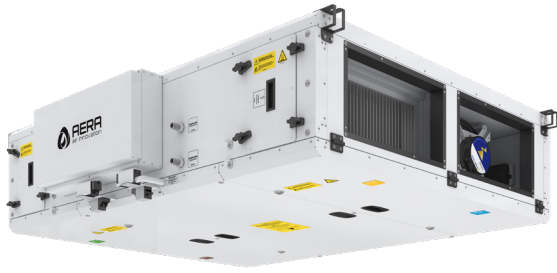

Fan Performance Curves

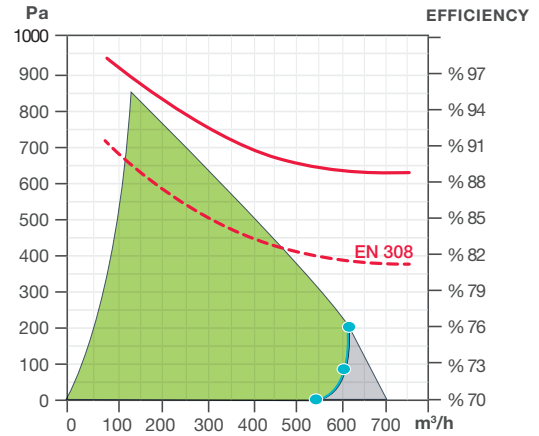

UNIT DATA

Exchanger Type	Counterflow Plate
Fan Type	EC Plug Fan
ERP Conformity	ERP 2018
Installation Space	Suspended Ceiling
Installation position	Horizontal
Service Side	From side and under
Casing	50 mm Insulated Double Walled

TECHNICAL DATA

Minimum Air Flow (m ³ /h)	170
Nominal Air Flow (m ³ /h)	500
Dry Efficiency (2)	84%
Standard Efficiency (3)	91%
Weight (kg)	130
Casing Performance (EN1886)	T2/TB2/D2
Fresh Air Filter	ISO ePM1 55% (F7)
Exhaust Air Filter	ISO ePM10 50% (M5)
Air Temperature(°C)	-20 / +50
Operational Temperature	0 / +50
IP Class	IP31

Sound Data (2)

Sound Power Supply Air dB(A)	78 @570 m ³ /h
Sound Power Exhaust Air dB(A)	61 @570 m ³ /h
Radiated Sound 1m.	42 @570 m ³ /h
Radiated Sound 3m.	33 @570 m ³ /h
Radiated Sound 5m.	28 @570 m ³ /h

Electrical Data

BMS Communication	BACnet, Modbus TCP/IP
Supply Voltage	230V 1N ~, 50 Hz
Max. Output Fans	2 x 170 W
Nominal Current	3.3

(2) Nominal Air Flow, EN308

(3) Nominal Air Flow, Wet Conditions

■ DIMENSIONS (mm)

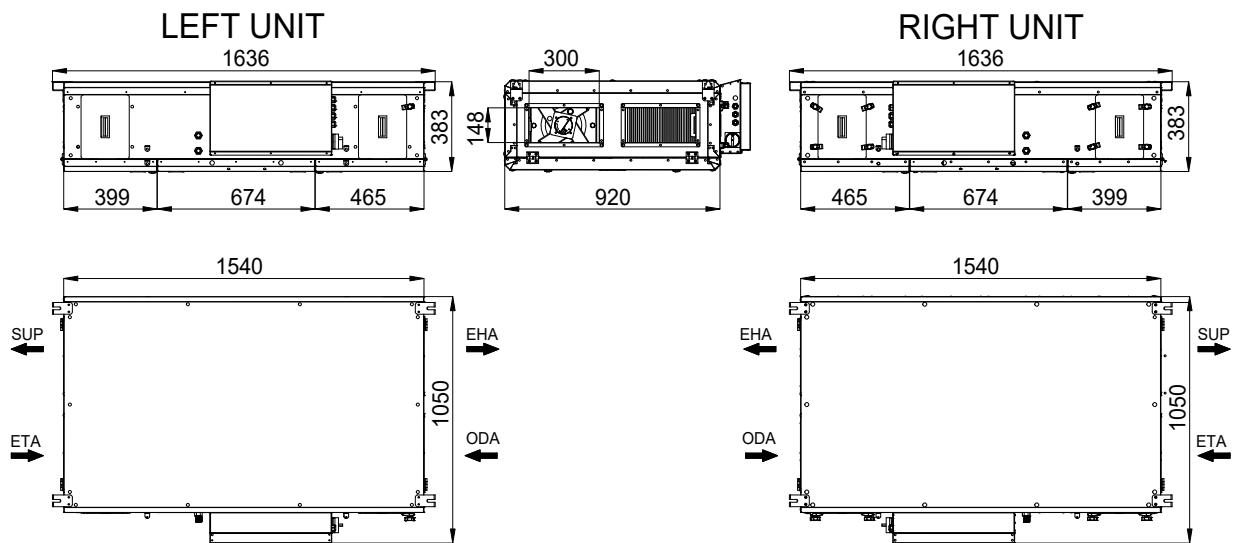

■ ACCESSORIES

Electrical Pre-heater	Optional	1P, 1600W, 7A
Electrical After heater	Optional	1P, 1600W, 7A
Water After heater	Optional	
Water Cooler	Optional	
DX Coil	Optional	
Damper	Optional	
Weather Protection kit	-	
Supply Air Spigot	-	
Exhaust Air Spigot	-	
Drain Pump	Optional	
Ball Siphon	Optional	
HMI Type-1	EVO ECO	
HMI Type-2	EVO TOUCH	
Cloud Connection	Optional	
VOD Sensor, CO2	Optional	
VOD Sensor, RH%	Optional	
VOD Sensor, VOC	Optional	
Signal Converter	Optional	
Constant Pressure Kit	Optional	
Exhaust Air Filter ePM10 50%	Standard	
Supply Air Filter (Pre-filter/ePM10 55%)	-	
Supply Air Filter ePM1 55%	Standard	
Supply Air Filter ePM1 80%	Optional	

You can find more information about accessories in the [ACCESSORIES](#) Section.



For our Current Certificates: www.aera.com.tr

AZURE 700

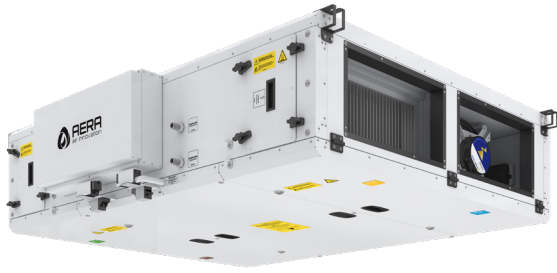

Fan Performance Curves

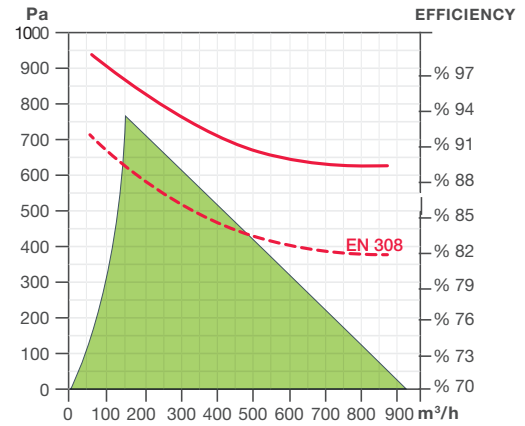

UNIT DATA

Exchanger Type	Counterflow Plate
Fan Type	EC Plug Fan
ERP Conformity	ERP 2018
Installation Space	Suspended ceiling
Installation position	Horizontal
Service Side	From side and under
Casing	50 mm Insulated Double Walled

TECHNICAL DATA

Minimum Air Flow (m ³ /h)	315
Nominal Air Flow (m ³ /h)	700
Dry Efficiency (2)	83%
Standard Efficiency (3)	90%
Weight (kg)	155
Casing Performance (EN1886)	T2/TB2/D2
Fresh Air Filter	ISO ePM1 55% (F7)
Exhaust Air Filter	ISO ePM10 50% (M5)
Air Temperature(°C)	-20 / +50
Operational Temperature	0 / +50
IP Class	IP31

Sound Data (2)

Sound Power Supply Air dB(A)	72 @680 m ³ /h
Sound Power Exhaust Air dB(A)	57 @680 m ³ /h
Radiated Sound 1m.	37 @680 m ³ /h
Radiated Sound 3m.	28 @680 m ³ /h
Radiated Sound 5m.	23 @680 m ³ /h

Electrical Data

BMS Communication	BACnet, Modbus TCP/IP
Supply Voltage	400V 3N ~, 50 Hz
Max. Output Fans	2 x 170 W
Nominal Current	3.0/0.0/0.3

(2) Nominal Air Flow, EN308

(3) Nominal Air Flow, Wet Conditions

■ DIMENSIONS (mm)

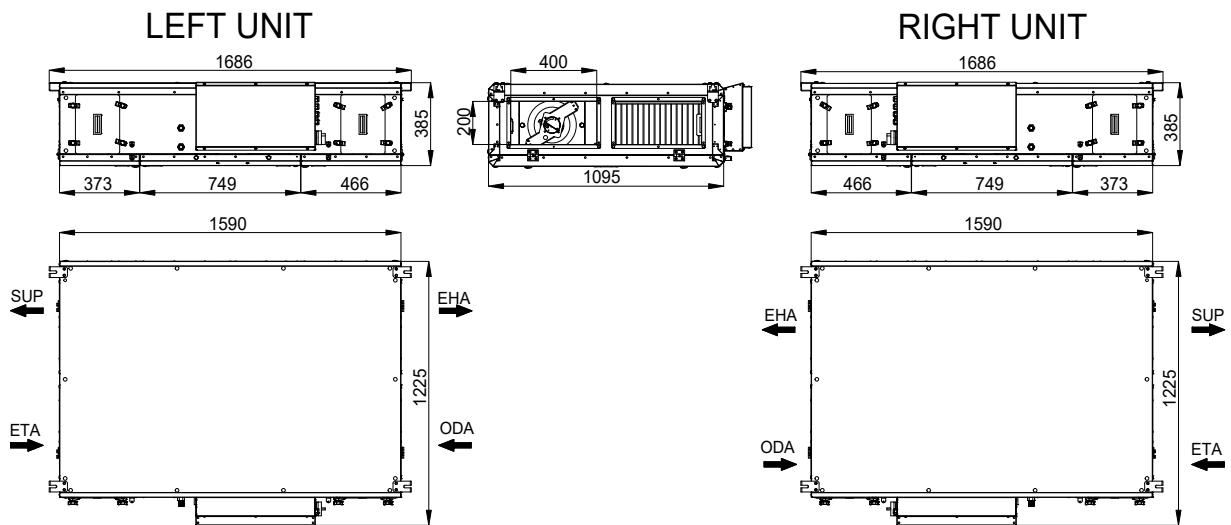

■ ACCESSORIES

Electrical Pre-heater	Optional	3P, 2300W, 3.8/3.8/3.8(A)
Electrical After heater	Optional	3P, 2300W, 3.8/3.8/3.8(A)
Water After heater	Optional	
Water Cooler	Optional	
DX Coil	Optional	
Damper	Optional	
Weather Protection kit	-	
Supply Air Spigot	-	
Exhaust Air Spigot	-	
Drain Pump	Optional	
Ball Siphon	Optional	
HMI Type-1	EVO ECO	
HMI Type-2	EVO TOUCH	
Cloud Connection	Optional	
VOD Sensor, CO2	Optional	
VOD Sensor, RH%	Optional	
VOD Sensor, VOC	Optional	
Signal Converter	Optional	
Constant Pressure Kit	Optional	
Exhaust Air Filter ePM10 50%	Standard	
Supply Air Filter (Pre-filter/ePM10 55%)	-	
Supply Air Filter ePM1 55%	Standard	
Supply Air Filter ePM1 80%	Optional	

You can find more information about accessories in the [ACCESSORIES](#) Section.



For our Current Certificates: www.aera.com.tr

AZURE 1400

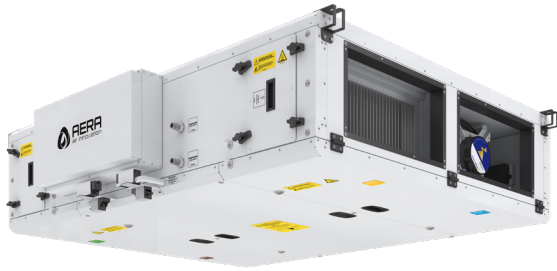

Fan Performance Curves

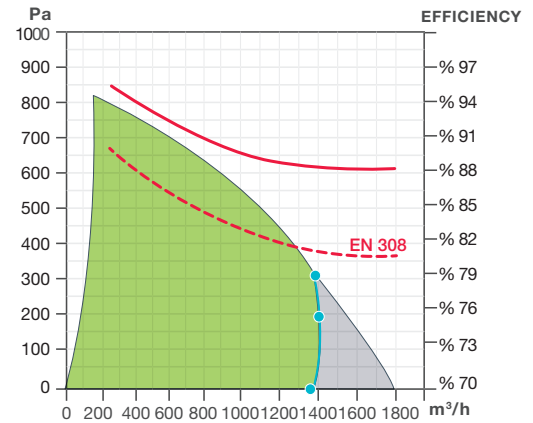

UNIT DATA

Exchanger Type	Counterflow Plate
Fan Type	EC Plug Fan
ERP Conformity	ERP 2018
Installation Space	Suspended ceiling
Installation position	Horizontal
Service Side	From side and under
Casing	50 mm Insulated Double Walled

TECHNICAL DATA

Minimum Air Flow (m³/h)	330
Nominal Air Flow (m³/h)	1400
Dry Efficiency (2)	84%
Standard Efficiency (3)	91%
Weight (kg)	200
Casing Performance (EN1886)	T2/TB2/D2
Fresh Air Filter	ISO ePM1 55% (F7)
Exhaust Air Filter	ISO ePM10 50% (M5)
Air Temperature(°C)	-20 / +50
Operational Temperature	0 / +50
IP Class	IP31

Sound Data (2)

Sound Power Supply Air dB(A)	79 @1450 m³/h
Sound Power Exhaust Air dB(A)	64 @1450 m³/h
Radiated Sound 1m.	45 @1450 m³/h
Radiated Sound 3m.	36 @1450 m³/h
Radiated Sound 5m.	31 @1450 m³/h

Electrical Data

BMS Communication	BACnet, Modbus TCP/IP
Supply Voltage	400V 3N ~, 50 Hz
Max. Output Fans	2 x 500 W
Nominal Current	2.2/2x2/0.3

(2) Nominal Air Flow, EN308

(3) Nominal Air Flow, Wet Conditions

■ DIMENSIONS (mm)

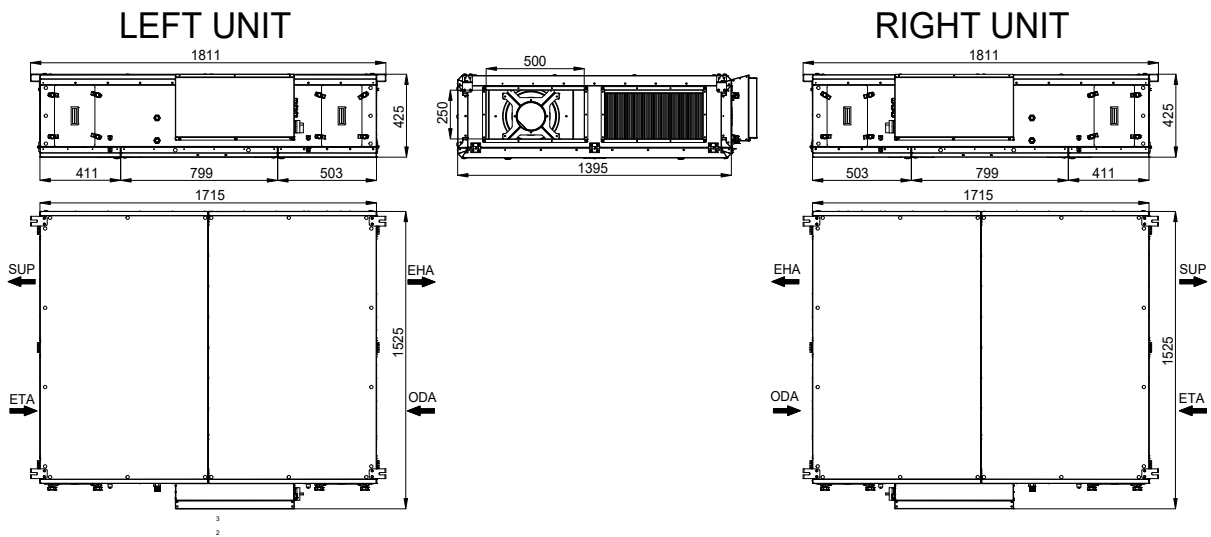

■ ACCESSORIES

Electrical Pre-heater	Optional	3P, 4500W, 6.5/6.5/6.5(A)
Electrical After heater	Optional	3P, 4500W, 6.5/6.5/6.5(A)
Water After heater	Optional	
Water Cooler	Optional	
DX Coil	Optional	
Damper	Optional	
Weather Protection kit	-	
Supply Air Spigot	-	
Exhaust Air Spigot	-	
Drain Pump	Optional	
Ball Siphon	Optional	
HMI Type-1	EVO ECO	
HMI Type-2	EVO TOUCH	
Cloud Connection	Optional	
VOD Sensor, CO2	Optional	
VOD Sensor, RH%	Optional	
VOD Sensor, VOC	Optional	
Signal Converter	Optional	
Constant Pressure Kit	Optional	
Exhaust Air Filter ePM10 50%	Standard	
Supply Air Filter (Pre-filter/ePM10 55%)	-	
Supply Air Filter ePM1 55%	Standard	
Supply Air Filter ePM1 80%	Optional	

You can find more information about accessories in the [ACCESSORIES](#) Section.



AZURE 2200



Fan Performance Curves

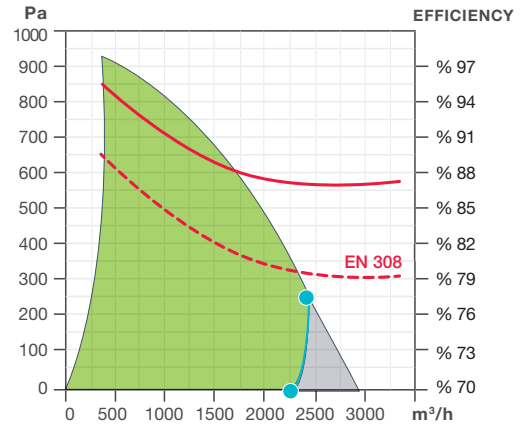

UNIT DATA

Exchanger Type	Counterflow Plate
Fan Type	EC Plug Fan
ERP Conformity	ERP 2018
Installation Space	Suspended ceiling
Installation position	Horizontal
Service Side	From side and under
Casing	50 mm Insulated Double Walled

TECHNICAL DATA

Minimum Air Flow (m ³ /h)	410
Nominal Air Flow (m ³ /h)	2200
Dry Efficiency (2)	83%
Standard Efficiency (3)	90%
Weight (kg)	285
Casing Performance (EN1886)	T2/TB2/D2
Fresh Air Filter	ISO ePM1 55% (F7)
Exhaust Air Filter	ISO ePM10 50% (M5)
Air Temperature(°C)	-20 / +50
Operational Temperature	0 / +50
IP Class	IP31

Sound Data (2)

	ISO 5136'ya göre
Sound Power Supply Air dB(A)	82 @2350 m ³ /h
Sound Power Exhaust Air dB(A)	67 @2350 m ³ /h
Radiated Sound 1m.	48 @2350 m ³ /h
Radiated Sound 3m.	39 @2350 m ³ /h
Radiated Sound 5m.	34 @2350 m ³ /h

Electrical Data

BMS Communication	BACnet, Modbus TCP/IP
Supply Voltage	400V 3N ~, 50 Hz
Max. Output Fans	2 x 780 W
Nominal Current	3.4/3.4/1.3

(2) Nominal Air Flow, EN308

(3) Nominal Air Flow, Wet Conditions

■ DIMENSIONS (mm)

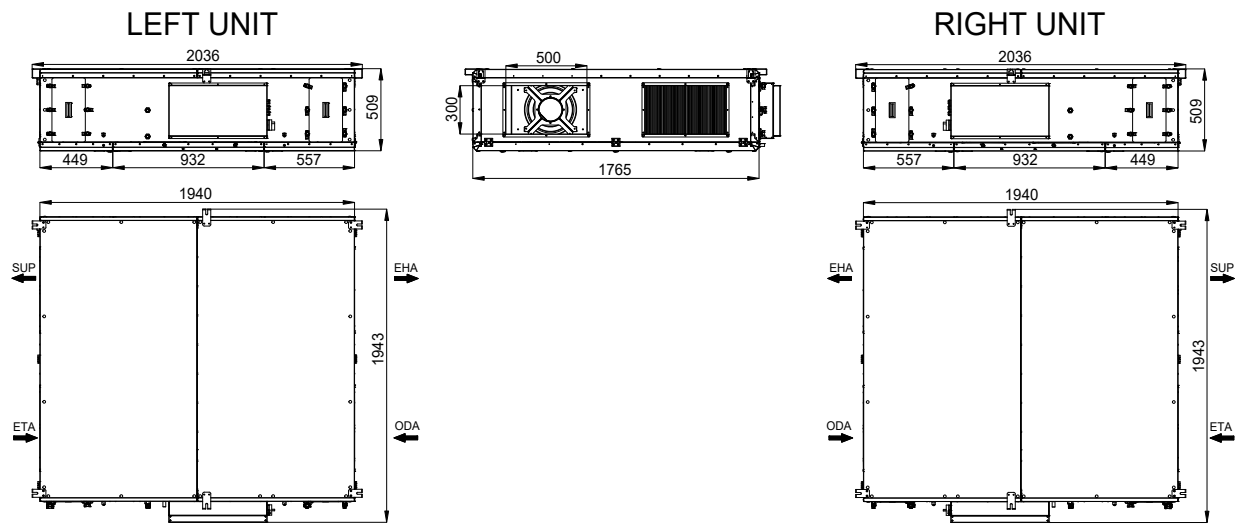

■ ACCESSORIES

Electrical Pre-heater	Optional	3P, 7050W, 10.2/10.2/10.2(A)
Electrical After heater	Optional	3P, 7050W, 10.2/10.2/10.2(A)
Water After heater	Optional	
Water Cooler	Optional	
DX Coil	Optional	
Damper	Optional	
Weather Protection kit	-	
Supply Air Spigot	-	
Exhaust Air Spigot	-	
Drain Pump	Optional	
Ball Siphon	Optional	
HMI Type-1	EVO ECO	
HMI Type-2	EVO TOUCH	
Cloud Connection	Optional	
VOD Sensor, CO2	Optional	
VOD Sensor, RH%	Optional	
VOD Sensor, VOC	Optional	
Signal Converter	Optional	
Constant Pressure Kit	Optional	
Exhaust Air Filter ePM10 50%	Standard	
Supply Air Filter (Pre-filter/ePM10 55%)	-	
Supply Air Filter ePM1 55%	Standard	
Supply Air Filter ePM1 80%	Optional	

You can find more information about accessories in the [ACCESSORIES](#) Section.



AZURE 3200

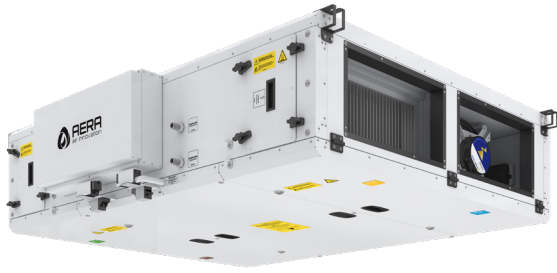

Fan Performance Curves

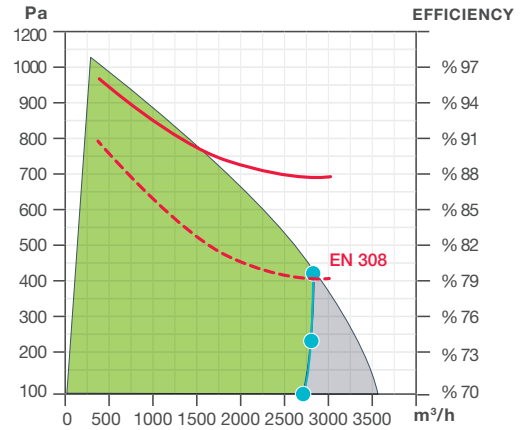

UNIT DATA

Exchanger Type	Counterflow Plate
Fan Type	EC Plug Fan
ERP Conformity	ERP 2018
Installation Space	Suspended ceiling
Installation position	Horizontal
Service Side	From side and under
Casing	50 mm Insulated Double Walled

TECHNICAL DATA

Minimum Air Flow (m ³ /h)	520
Nominal Air Flow (m ³ /h)	3200
Dry Efficiency (2)	83%
Standard Efficiency (3)	90%
Weight (kg)	370
Casing Performance (EN1886)	T2/TB2/D2
Fresh Air Filter	ISO ePM1 55% (F7)
Exhaust Air Filter	ISO ePM10 50% (M5)
Air Temperature(°C)	-20 / +50
Operational Temperature	0 / +50
IP Class	IP31

Sound Data (2)

Sound Power Supply Air dB(A)	86 @3100 m ³ /h
Sound Power Exhaust Air dB(A)	71 @3100 m ³ /h
Radiated Sound 1m.	53 @3100 m ³ /h
Radiated Sound 3m.	43 @3100 m ³ /h
Radiated Sound 5m.	39 @3100 m ³ /h

Electrical Data

BMS Communication	BACnet, Modbus TCP/IP
Supply Voltage	400V 3N ~, 50 Hz
Max. Output Fans	2 x 1300 W
Nominal Current	5.7/5.7/0.3

(2) Nominal Air Flow, EN308

(3) Nominal Air Flow, Wet Conditions

■ DIMENSIONS (mm)

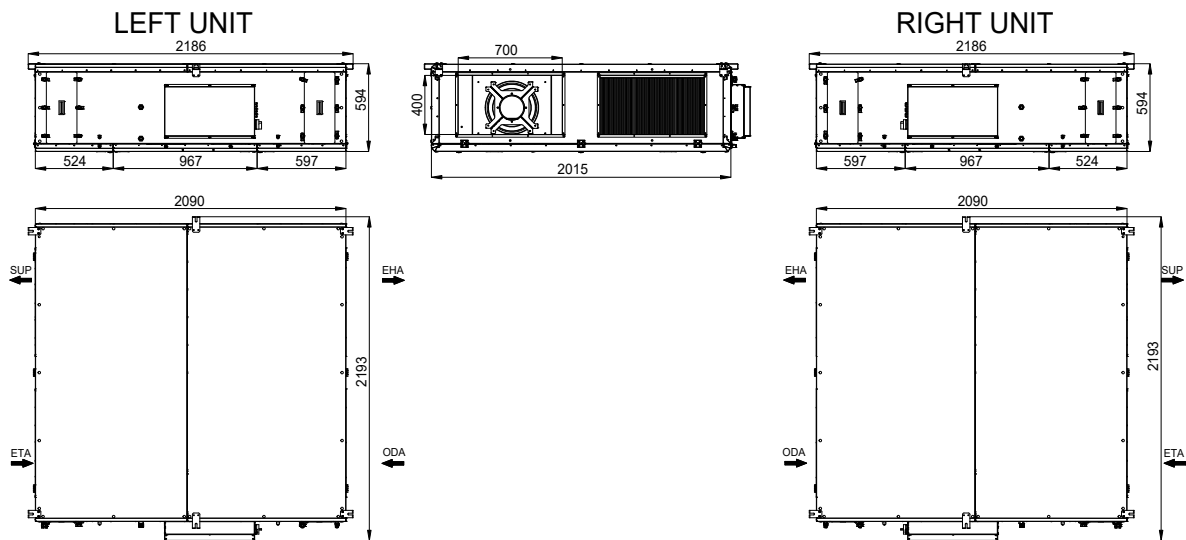

■ ACCESSORIES

Electrical Pre-heater	Optional	3P, 10500W, 15.2/15.2/15.2(A)
Electrical After heater	Optional	3P, 10500W, 15.2/15.2/15.2(A)
Water After heater	Optional	
Water Cooler	Optional	
DX Coil	Optional	
Damper	Optional	
Weather Protection kit	-	
Supply Air Spigot	-	
Exhaust Air Spigot	-	
Drain Pump	Optional	
Ball Siphon	Optional	
HMI Type-1	EVO ECO	
HMI Type-2	EVO TOUCH	
Cloud Connection	Optional	
VOD Sensor, CO2	Optional	
VOD Sensor, RH%	Optional	
VOD Sensor, VOC	Optional	
Signal Converter	Optional	
Constant Pressure Kit	Optional	
Exhaust Air Filter ePM10 50%	Standard	
Supply Air Filter (Pre-filter/ePM10 55%)	-	
Supply Air Filter ePM1 55%	Standard	
Supply Air Filter ePM1 80%	Optional	

You can find more information about accessories in the [ACCESSORIES](#) Section.



For our Current Certificates: www.aera.com.tr

■ ELECTRICAL PREHEATER

Electrical pre-heaters are provided as an effective solution for climates characterized by extremely low outdoor air temperatures. They play a pivotal role in mitigating the risk of freezing, thereby preventing blockages within the heat exchanger and safeguarding against mechanical damage. Control is implemented through a single-stage process when using SENSO control, and further enhanced

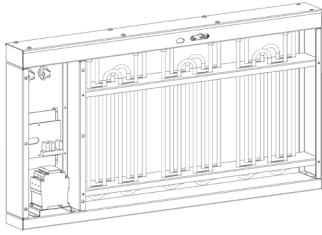

Model	Heater Capacity (kW)	Current (A)	Control
AZ-PREH 500	1,6	7	Proportional
AZ-PREH 700	2,3	3,3	Proportional
AZ-PREH 1400	4,5	6,5	Proportional
AZ-PREH 2200	7,05	10,2	Proportional
AZ-PREH 3200	10,5	15,2	Proportional

■ ELECTRICAL AFTER HEATER

Electrical after heaters are available to elevate the supply air temperature, making it particularly useful in situations where increased thermal output is required. It operates autonomously, responding dynamically to the specified room temperature or the target supply temperature. When integrated with SENSO control, it operates as a 1~3 step control process (depending on the availability of a pre-heater and capacity), ensuring precise thermal regulation. Moreover, when utilized in conjunction with SENSO+ control, it delivers fine-tuned energy efficiency control through the utilization of a proportional signal, enabling precise and efficient temperature management.

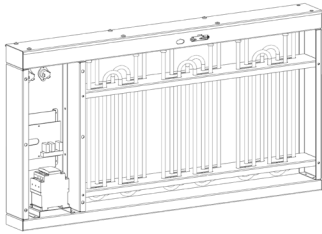

Model	Heater Capacity (kW)	Water Regime (A)	Control
AZ-POEH 500	1,6	7	Proportional
AZ-POEH 700	2,3	3,3	Proportional
AZ-POEH 1400	4,5	6,5	Proportional
AZ-POEH 2200	7,05	10,2	Proportional
AZ-POEH 3200	10,5	15,2	Proportional

■ WATER AFTER HEATER

Water after-heaters are deployed to elevate the supply air temperature, this system operates autonomously, seamlessly aligning itself with either the desired room temperature or the specified supply temperature. When integrated with SENSO control, it executes control in a single step (on/off), ensuring precise temperature regulation. Furthermore, when harnessed alongside SENSO+ control, it achieves highly controllable energy efficiency through the utilization of a proportional signal, enabling meticulous management of thermal performance.

Model	Heater Capacity (kW)	Water Regime (A)	Control
AZ-POWH 500	1,6	80-60	Proportional
AZ-POWH 700	2,3	80-60	Proportional
AZ-POWH 1400	4,5	80-60	Proportional
AZ-POWH 2200	7,05	80-60	Proportional
AZ-POWH 3200	10,5	80-60	Proportional

■ WATER COOLING

Used for cooling inside, water type cooling batteries are existed as accesories. With SENSO+ control, controlled proportionally according to desired supply temperature or desired room temperature.

Model	Heater Capacity (kW)	Current (A)	Control
AZ-KR 500	1,5	7-12	Proportional
AZ-KR 700	2	7-12	Proportional
AZ-KR 1400	4	7-12	Proportional
AZ-KR 2200	6	7-12	Proportional
AZ-KR 3200	9	7-12	Proportional

■ Duct Connection Damper

The motor operated damper, as turned itself off when the devices is turned off, prevent the leakage can be occurred via air duct. It can be implemented in or out of device. Has the Class 3 impermeability as a standard.

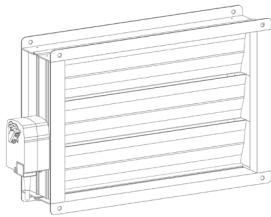

Model	Opening Time	ELC Connector
AZ-DAMP 500	40...75 s	24C DC , spring return
AZ-DAMP 700	40...75 s	24C DC , spring return
AZ-DAMP 1400	40...75 s	24C DC , spring return
AZ-DAMP 2200	40...75 s	24C DC , spring return
AZ-DAMP 3200	40...75 s	24C DC , spring return

■ Drainage Pump

Used when unloading the water occurred from condensation at the exchanger or battery cell in the device not possible via the present slope.

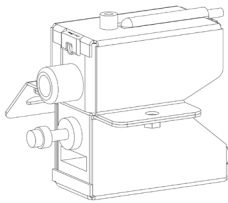

Model	Max. Flow(l/h)	Max. Elevatron Height(m)	Max. Suction Height(m)	ELC Connector
DP 01	13	10	1,5	230 V, 50/60 Hz
DP 02	40	10	2	230 V, 50/60 Hz

■ FILTER

The units come equipped with filters designed to meet ECO-DESIGN criteria, including ePM10 50% (M5) extra filters and ePM1 55% (F7) outdoor air filters as standard components. Depending on the prevailing outdoor air quality and the specific requirements of projects, optional accessories can be employed, such as a pre-filter featuring ePM10 50% (M5) filtration class for fresh air intake, or an advanced filter with ePM1 80% (F9) filtration class for fresh air, allowing for tailored air filtration based on project needs and specifications.

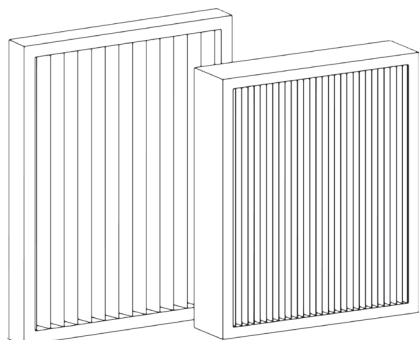

Model	Code
Fresh air filter ePM10 50%	AZ500FAEPM10-50
	AZ700FAEPM10-50
	AZ1400FAEPM10-50
	AZ2200FAEPM10-50
	AZ3200FAEPM10-50
Fresh air filter ePM1 80%	AZ500FAEPM1-80
	AZ700FAEPM1-80
	AZ1400FAEPM1-80
	AZ2200FAEPM1-80
	AZ3200FAEPM1-80

■EVO-ECO

The bottom-based user interface in these units incorporates a user panel and is seamlessly integrated with the SENSO+ control card. It is connected to the control panel using either a 4x0.75 cable or an RJ-12 Jack, facilitating intuitive and efficient control and communication.



Model
EVO-ECO

■EVO-TOUCH

Utilized as the user interface, a 4-inch touch-type user panel is incorporated into the system. This user panel is seamlessly connected to the control panel via either a 4x0.75 cable or an RJ-12 Jack, ensuring user-friendly interaction and efficient communication.



Model
EVO-TOUCH

■VOD

Positioned within the critical volume or return duct, an optional air quality sensor (VOC or CO₂) or relative humidity sensor (RH%) consistently monitors the air quality or relative humidity levels. This data is then compared to a predefined set value configured in the control system, which in turn triggers adjustments to the EC fan's speed. If the air quality in the room falls below the desired level or if the relative humidity exceeds the set threshold, the fan speed is increased, resulting in a higher volume of fresh air being supplied. Conversely, if the air quality surpasses the desired level or the relative humidity drops below the target value, the fan speed is reduced, leading to a decrease in the fresh air supply. This intelligent control mechanism not only ensures optimized air quality but also significantly reduces energy consumption associated with heating or cooling loads stemming from fresh air circulation.



Model	Measurement	Installation Position
VOD-VOC-RM	VOC	Room
VOD-VOC-DUCT	VOC	Channel
VOD-CO ₂ -DUCT	CO ₂	Room
VOD-CO ₂ -RM	CO ₂	Channel
VOD-RH-DUCT	RH%	Room
VOD-RH-RM	RH%	Channel
PS-MW	-	-

■ CLOUD CONNECTION

The web server on SENSO+, as connecting to web, via a computer/tablet or a mobile phone at anywhere in the world, operating situation can be viewed and the access for changing the settings is provided. Without needing a complex web settings, this feature can be activated with a simple web connected cable.



Model
SENSO+ CLOUD

■ Constant Pressure Kit

Used for serving the purpose of ventilation system's varying flow rate. SENSO+, creates the signal which can change EC fan's fan speed as measuring static pressure value consistently, as comparing with defined value to the system. Turning up or down the VAV damper which are different volume in duct system, serve the purpose of static pressure out of device as a result of higher or lower values than projected values with constant pressure control. In the fan operating characteristic, extreme volume sound occurred in the ducts and flow rate in different volumes are prevented.



Model
SENSO+-CAP

■ Signal Converter

SENSO+ devices as make an access that connect up to 3 VOD sensors, both measure gas and different volume gases, change the capacity according to these measurements of air conditioning plants. Via Signal Converter, in 3 different types, for each type up to 6 measurements or obtained values from 18 different measurement volumes are used for controlling air conditioning plant is provided.



Model
SENSO+ SK

■ BALL SIPHON

Used for disposal of water In the heat recovery sections, the result of condensation at the exhaust air or the result of condensation at the cooking batteries. Can operate in both positive negative pressure.

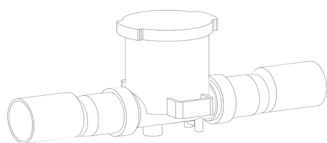

Model
SIPH



**AERA Air Conditioning Ventilation
Technologies Corporation**

Factory I: 14. Cadde, No:13, Pancar OSB

Factory II: 3. Cadde, No:13, Pancar OSB

Torbalı/İzmir-Türkiye, +90 232 799 01 11

E-mail: sales@aera.com.tr

Sales Headoffice: Özdemir Sok. Kurtuluş Apt. No: 5

Kadıköy/İstanbul-Türkiye, +90 216 504 76 86



aera.com.tr

